

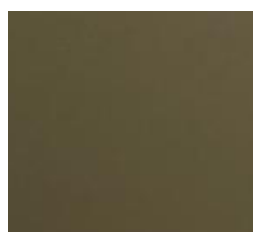

A linha da vida

C A T Á L O G O 2 0 2 2

ACABAMENTOS



LACA DESERTO

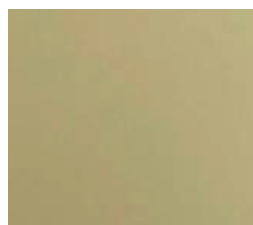

LACA FENDI

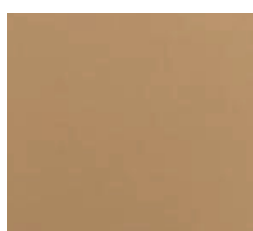

LACA ROSÉ

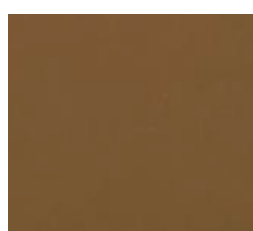

LACA TRUFA

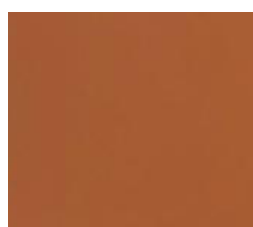

LACA
TERRACOTA

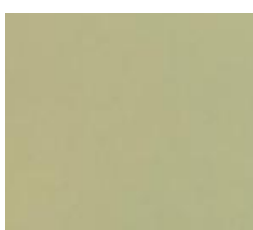

LACA
VERDE



LACA
CIMENTO

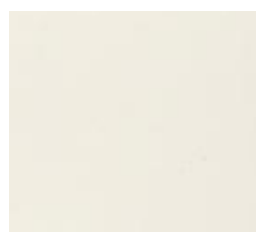

LACA
BRANCA

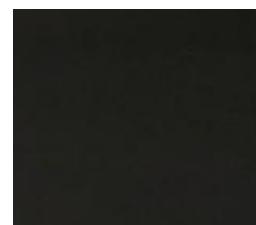

LACA
PRETA



LACA
CETIM

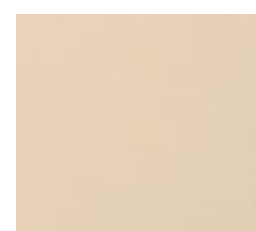

LACA
NUDE

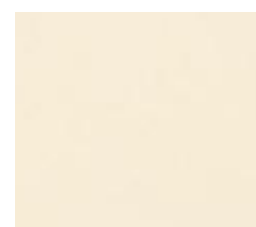

LACA
CAMURÇA

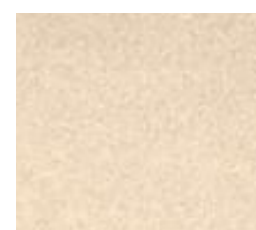

LACA
METALIZADA
CHAMPAGNE

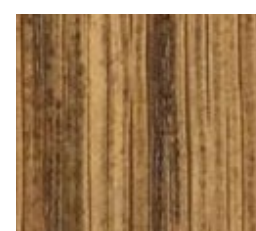

NOGUEIRA

ACABAMENTOS



LACA
CREME



LACA
CAMELO

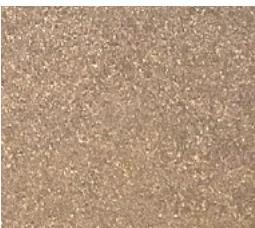

LACA
METALIZADA
DOURADA

ALMOFADAS

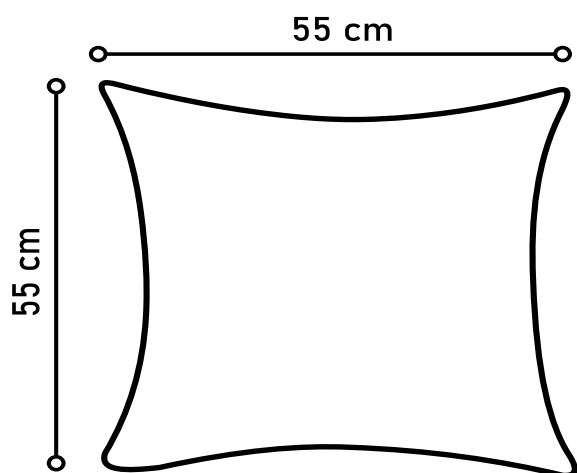

REF 4005

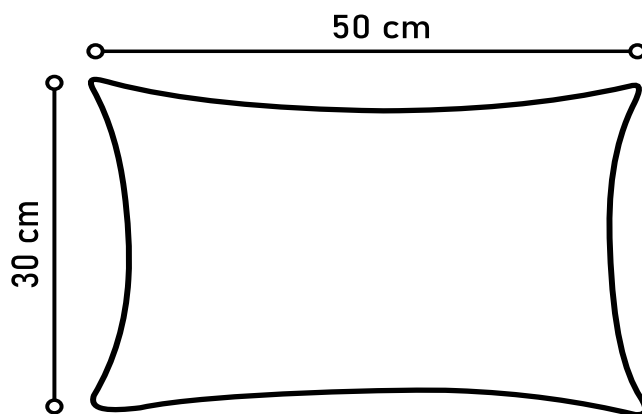

REF 4008

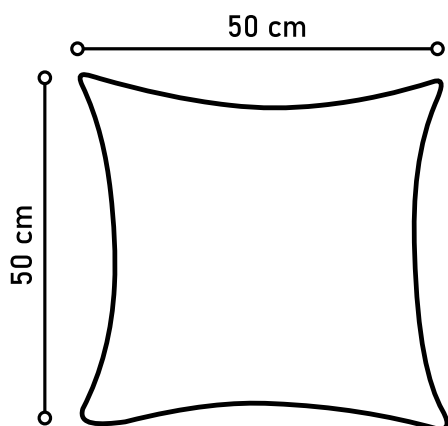

REF 4006

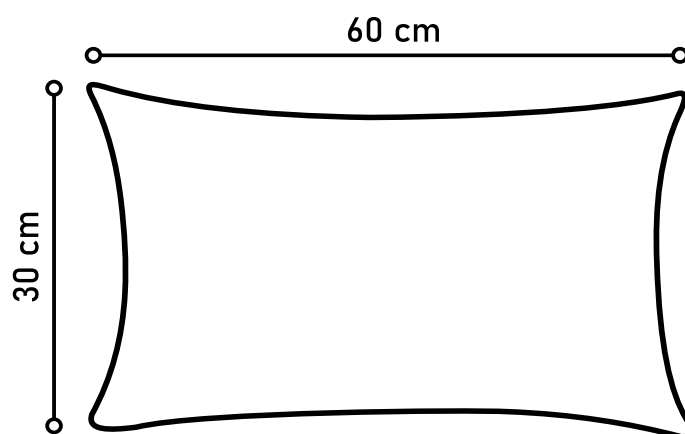

REF 4009

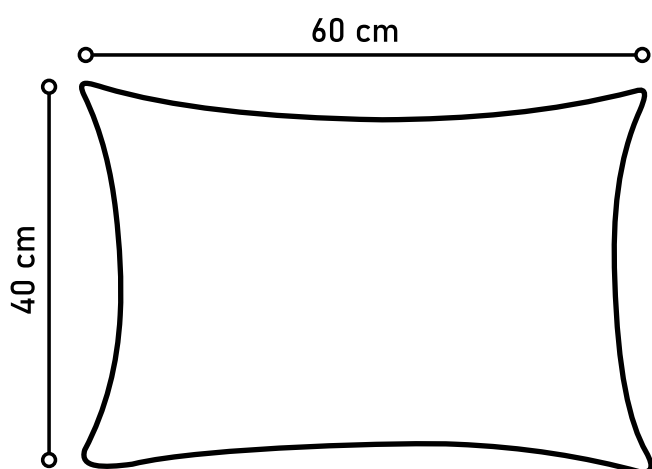

REF 4007

DISPONÍVEL EM:

- LINHOS
- TEARES
- SOLTOS
- BARBANTE
- MALHAS

LINHOS



L15 - CINZA CLARO



L26 - TRAMADO
BEGE



L17 - CAMELO



L27 - AZUL



L18 - RÚSTICO
NATURAL



L28 - CINZA
MESCLA



L20 - ROSE



L31 - AREIA



L23 - CINZA
ESCURO

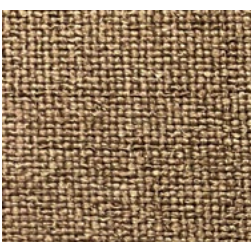

L32 - TRUFA



L24 - TRAMADO
CINZA



L33 - BEGE
CLARO

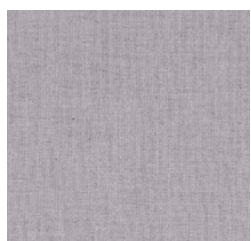

L25 - CINZA MÉDIO

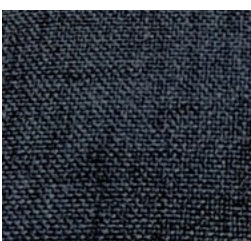

L35 - AZUL
ESCURO

LINHOS

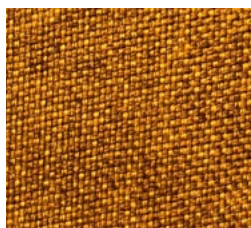

L36 - AMARELO
OCRE



L38 - FERRUGEM



L39 - ROSE



L41 - LINHO
MESCLA BEGE

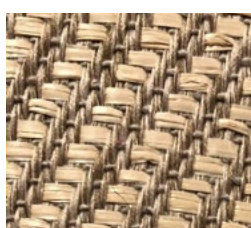

L42 - LINHO
PALHA

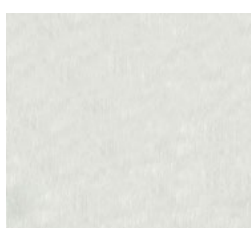

L43 - ALGODÃO
CRÚ



L44 - LINHO
CRÚ



L45 - LINHO
ROSA



L46 - FAVOS



L47 - TRAMA ROSE



L48 - MOSTARDA



L49 - ALGODÃO
FENDI



L50 - VERDE
MILITAR



L51 - LINHO PRETO

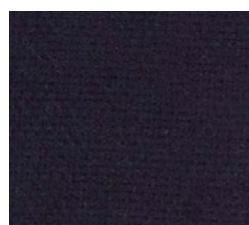

D02 - RÚSTICO
PRETO

VELUDOS

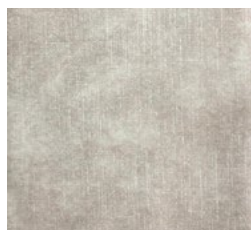

V14 - BEGE
MESCLA

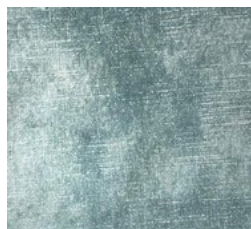

V15 - VERDE
CLARO



V16 - VERDE

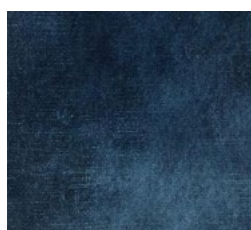

V17 - AZUL ROYAL

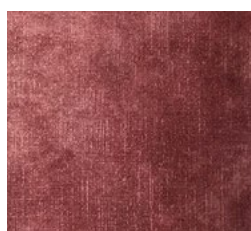

V18 - ROSA
ANTIGO

TEARES



T01 - COLMÉIA



T35 - COLMÉIA
CARAMELO



T09 - CROCHÊ
CRÚ



T41 - GEOMÉTRICO
NATURAL

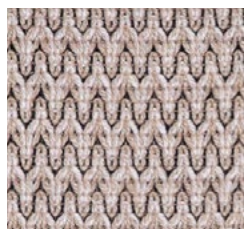

T12 - CORDAS MESCLA



T42 - CORDAS



T18 - FAVOS



T45 - TIJOLINHO
CRÚ



T23 - MISSONI PÉROLA



T46 - TRAMA
NATURAL



T26 - CORDÃO



T28 - TRAMA CINZA

SOLTOS



TS05 - TRAMA
LOSANGO DUPLO



TS20 - TRAMA
CORDAS NATURAL

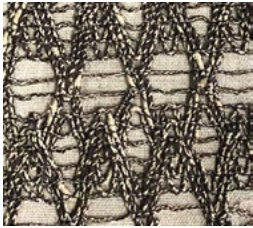

TS10 - TRAMA
CORDÃO MESCLADO



TS12 - LOSANGO
CAMELO



TS14 - TRAMA
CORDAS NATURAL



TS17 - ONDAS



TS18 - ONDAS
NATURAL



TS19 - GEOMÉTRICO
PRETO

MALHAS



MALHA CRÚ

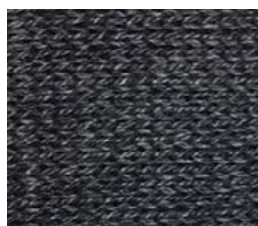

MALHA AZUL

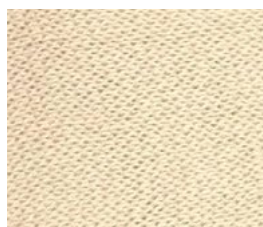

MALHA FENDI

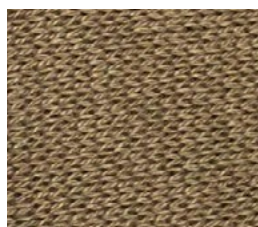

MALHA TRUFA

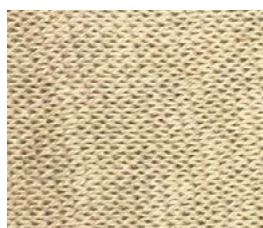

MALHA NATURAL



MALHA VERDE



MALHA NUDE



MALHA CINZA



MALHA ROSA
ANTIGO



MALHA MARROM



MALHA
TERRACOTA

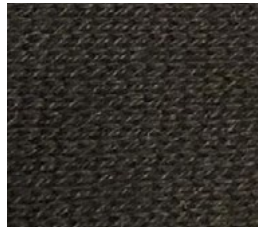

MALHA PRETA



MALHA
OCRE

HISTÓRIA

Sentimento, amor e dedicação. Palavras que descrevem a marca Rosa Maria como nenhuma outra.

Criada a partir de um sonho, a marca se tornou única no ramo de decoração em território nacional, levando consigo toda a identidade da artista Rosa Maria — com força e originalidade de mãos que criam.

O diferencial da marca está nas pessoas que fazem parte dela. Delicadeza, elegância e criatividade ganham formas exclusivas levando sofisticação aos ambientes que decoram.

WWW.ROSAMARIADECORACAO.COM.BR



ROSAMARIADECORHOME



ROSAMARIADECORACAO

RUA PRIMEIRO DE MAIO - 192 - CENTRO
GARIBALDI / RS